

Opp. ruwheid (zie NEN 3634)	Maattoleranties NEN-ISO 2768-	MATERIAAL: Staal	Vorm- en plaatstol. (zie NEN-ISO11010)
	SCHAAL: 1:5	GETEKEND: Hanne Schellens	OPMERKING:
	MAATEENHEID: mm	AFDELING: Engineering	
	DATUM: 26-06-2021	GEZIEN:	
		BENAMING:	NUMMER: 01
			A4

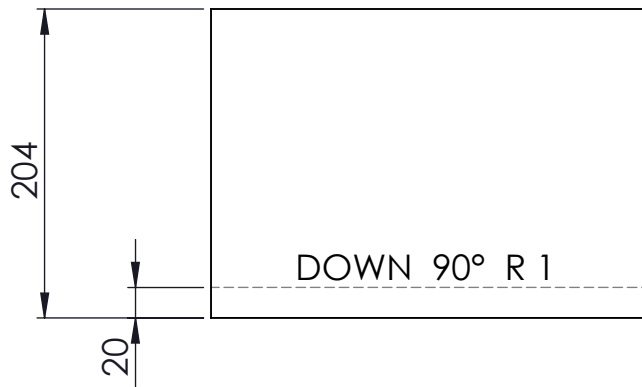

Opp. ruwheid (zie NEN 3634)	Maattoleranties NEN-ISO 2768-	MATERIAAL: Staal	Vorm- en plaatstol. (zie NEN-ISO11010)
	SCHAAL: 1:5	GETEKEND: Hanne Schellens	OPMERKING:
	MAATEENHEID: mm	AFDELING: Engineering	
	DATUM: 26-06-2021	GEZIEN:	
		BENAMING:	NUMMER: 01
			A4